



EGUANA



Evolve Hub Max
Installation Manual

For use with the Evolve LFP Max energy storage systems

IMPORTANT SAFETY INSTRUCTIONS

SAVE THESE INSTRUCTIONS

This manual contains important instructions for the Evolve™ Hub Max as part of a complete home energy storage system. The Evolve Hub is a peripheral of the Evolve LFP Max energy storage system.



CAUTION: Hazardous Voltages! This product contains hazardous voltage and energy that may be lethal. It may only be installed by qualified personnel who have read this manual and are familiar with its operation and hazards. The following safety procedures should be followed:

Only connect the Evolve Hub Max to a compatible electrical service as defined in the model specifications.

Ensure proper electrical grounding in accordance with code requirements.

Ensure proper airflow path for active cooling.

Only qualified personnel should service this product.

Ensure cover is securely fastened after installation is complete.

Do not attempt to operate this product if there is any physical evidence of damage to the enclosure or internal components.



WARNING! This product contains an AGM sealed lead acid battery. A battery can present a risk of electrical shock, and a burn from high short-circuit current.



CAUTION! This product must be stored indoors in an environmentally conditioned location prior to installation, protected from rain and exposure to any hazardous chemicals. Inspect the battery case prior to installation. Do not install and power the product if there appears to be damage to the battery. Contact your local product distributor if you suspect any damage to the battery.



IMPORTANT! When replacing the battery, use the same type of battery. Use AGM sealed lead acid battery with dimensions and ratings as shown. Consult Eguana tech support for approved replacements.

Proper disposal of batteries is required. Consult your local codes for disposal requirement.

California Proposition 65



WARNING! This product can expose you to chemicals including bis (2-ethylhex-yl)phthalate, which is known to the State of California to cause birth defects or other reproductive harm. For more information go to <https://www.p65warnings.ca.gov/>.

DIMENSIONS: inch (mm)

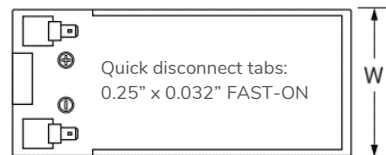

L: 5.95 (151)
W: 2.56 (65)
H: 3.70 (94)
HT: 3.86 (98)

Tolerances are +/- 0.04 in. (+/- 1mm) and +/- 0.08 in. (+/- 2mm) for height dimensions. All data subject to change without notice.

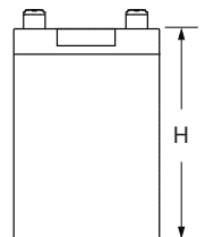
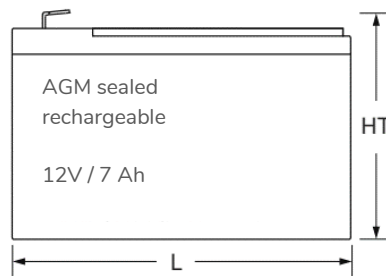





Contents

1 SAFETY	1
1.1 IN CASE OF EMERGENCY	1
1.2 BATTERY SAFETY PRECAUTIONS	1
1.3 GENERAL SAFETY PRECAUTIONS	2
1.4 DISPOSAL AND RECYCLING	2
2 INTRODUCTION	3
2.1 ABOUT THIS MANUAL – SUPPORTING DOCUMENTS.....	3
2.2 GLOSSARY	3
2.3 INITIAL INSPECTION OF MATERIAL LIST	3
2.4 SPECIAL TOOLS & HARDWARE	4
2.5 FUNCTIONAL OVERVIEW	4
2.5.1 Grid Connected Solar plus Storage.....	4
2.5.2 Backup Solar plus Storage.....	4
2.5.3 Backup Solar PV curtailment method: Frequency Shift Power Control (FSPC).....	5
2.5.4 PV AC input limit.....	5
2.5.5 Over-sized PV systems.....	5
2.6 INTERNAL COMPONENT OVERVIEW	6
2.6.1: Energy management controller (EMC)	6
3 INSTALLATION PLANNING	7
3.1 INSTALLATION CLEARANCES BETWEEN THE EVOLVE HUB MAX AND THE BATTERY SYSTEM.....	7
3.2 INSTALLATION CONDUIT PLAN – POWER AND COMMUNICATION CIRCUITS	8
3.3 SLD - AC COUPLED PV SYSTEM WITH BACK-UP POWER OPERATION.....	9
4 INSTALLATION INSTRUCTIONS	10
5 ELECTRICAL WIRING INSTRUCTIONS	10
5.1 EMC TO PCS CABLE	10
5.2 GRID & ATS MONITORING CABLES.....	11
5.3 AC POWER WIRING	11
5.3.1 Phase orientation in split phase 120/240 systems.....	11
5.3.2 Main electrical panel.....	12
5.3.3 PV.....	13
5.3.4 Load (Backup panel).....	13
5.3.5 LFP Max PCS.....	13
5.4 CT CONNECTIONS.....	13
5.4.1 Main electrical panel CTs.....	13
5.4.2 Solar PV CT.....	13
5.4.3 PCS CTs	14
5.5 12V BACKUP BATTERY.....	14
6 OPERATION	14
6.1 EMC SELECTOR SWITCH: EMC_B.....	14
6.2 PRE-STARTUP CHECKLIST	14
6.3 STARTUP	14
6.4 POST-STARTUP CHECKLIST	15
7 MAINTENANCE	15
8 TROUBLESHOOTING	15
9 TECHNICAL DATA	16
9.1 ELECTRICAL SPECIFICATIONS	16
9.2 WIRE AND TORQUE RATINGS	16

1 Safety

The components described by this manual are intended to be used as part of an energy storage system and installed per all local building codes and regulations in addition to the National Electrical Code, ANSI/NFPA 70 (for US) and Canadian Electrical Code (for Canada).

Throughout this manual, the following symbols will be used to highlight important information and procedures:

Symbol	Definition	Symbol	Definition
	WARNING! A dangerous voltage or other condition exists. Use extreme caution when performing these tasks.		Meter measurement required.
	CAUTION! This information is critical to the safe installation and or operation of the inverter. Follow these instructions closely.		Torque rating critical to operation.
	NOTE: This statement is important. Follow instructions closely.		Login to the remote monitoring system for operating status

1.1 In case of emergency

In all cases:

- If safe to do so, switch off the AC breakers (external to the system).
- Contact the fire department or other required emergency response team.
- Evacuate the area, and if applicable, follow your emergency evacuation plan if others are in proximity to the installed location.

In case of fire:

- When safe, use a fire extinguisher suitable for use; including A, B, and C dry chemical fire extinguishers or carbon dioxide extinguishers.

In case of flooding:

- Stay out of water if any part of the system or wiring is submerged.
- Do not attempt to operate batteries that have been submerged in water even after they have been dried.

In case of unusual noise, smell or smoke:

- If safe to do so, ventilate the area.

1.2 Battery safety precautions

This product is integrated with an AGM type 12V, 9 Ah battery. Refer to the product manual for complete safety instructions regarding the battery supplied with this product.

1.3 General safety precautions



Important! Installation, service, and operating personnel must read this document in its entirety, and observe all safety and installation procedures as described in this manual. Never operate system in a manner not described by this manual.

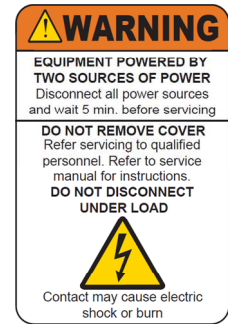

Only qualified personnel should service this product.

Ensure all covers are securely fastened after installation is complete.

Personal Protective Equipment (PPE) in compliance with local work place safety standards must be worn when working inside the cabinet.

Risks of Fire

Do not expose the system to temperatures exceeding 60 degrees Celsius.

Avoid installation in direct sunlight.

Do not store objects on top of the cabinet.

Do not obstruct the airflow paths of the cabinet air intake.

Do not obstruct the exhaust of cabinet exhaust.

Do not store combustible objects and corrosive chemicals directly adjacent to the system.

Risks of Shock



WARNING! Hazardous Voltages. The Inverter contains hazardous voltage and energy that may be lethal. It may only be installed by qualified personnel who have read this manual and are familiar with its operation and hazards.



Only connect this product to a compatible electrical service as defined in the model specifications. This product must be connected to a dedicated branch circuit in the main electrical panel.

Ensure proper electrical grounding in accordance with code requirements.

Risks of Damage

Do not drop, tip, or puncture the cabinet during transport and installation. Visible damage to the cabinet and/or internal components should be reported to the manufacturer immediately.

Do not store this system for periods longer than six months without a battery maintenance charge. This may result in permanent damage to the battery.





1.4 Disposal and Recycling



Do not dispose of the system or any of the components within the cabinet. Batteries, electronics, cables, and metal parts are recyclable. Consult your municipal waste management authority to determine required methods of component recycling.

2 Introduction

Throughout this manual, the following symbols will be used to highlight important information and procedures:

Symbol	Definition	Symbol	Definition
	WARNING! A dangerous voltage or other condition exists. Use extreme caution when performing these tasks.		Function performed by energy management system / controller.
	CAUTION! This information is critical to the safe installation and or operation of the product. Follow these instructions closely.		NOTE: This statement is important. Follow instructions closely.

2.1 About this manual – supporting documents

This manual is intended to be used by qualified service and installation personnel for the purposes of installation and startup only. The energy management system & gateway within the Hub requires installer administration and device commissioning prior to operation of the Evolve LFP Max energy storage system. Refer to the Fleet Installer Administration Guide and the Evolve Hub Max Install and Commission Quick Guide for further details.

This product is permanently wired to the home electrical service, and must be installed by a licensed electrician only. This product is a power distribution peripheral intended to be operated with external batteries in the Evolve energy storage system. A complete list of Installer resources is available at www.eguanatech.com under the Evolve™ product banner.

2.2 Glossary

Term	Definition	Term	Definition
AC / DC	Alternating Current / Direct Current	NC/NO	Normally Closed / Normally Open
AHJ	Authority Having Jurisdiction	NEC/CEC	National (USA) Electric Code / Canadian Electric Code
ARC	Auto Recovery Control	PCS	Power Control System (Inverter)
EMC	Energy Management Controller	PE (GND)	Protective Earth
EMS	Energy Management System	PV	Photo-Voltaic
ESS	Energy Storage System	RF	Radio Frequency
GND	Ground	SOC	State Of Charge (Battery)
LED	Light Emitting Diode	SOH	State of Health (Battery)

2.3 Initial Inspection of Material List

The system components supplied with your Eguana Evolve™ Hub Max are shown below. Each component should be inspected visually for any damage that may have been caused by shipment. If parts are missing or damaged, please contact your local distributor.

Item	Description
1	Evolve Hub Max
2	Current transformer – 200 Amp
3	Current transformer – 50 Amp
4	EMC to PCS RJ-45 cable
5	Grid monitor cable (6-wire)
6	ATS monitor cable (5-wire)
7	USB to Mini-USB service cable



Figure 1: Evolve Hub Max materials list.

2.4 Special Tools & Hardware

In addition to the standard tools required for enclosure mounting, the following tools should be readily available to complete the installation.

- Drill and hole saw kit
- RJ-45 crimp tool and RJ-45 connectors
- Wall mounting hardware.
- #0 flat screwdriver.

2.5 Functional Overview

The Evolve Hub Max is equipped to support an AC coupled solar plus storage installation with backup power to a dedicated backup electrical panel. The Hub is a power distribution center for the Evolve LFP Max (herein referred to as the ESS), routing all AC power between the main and backup electrical panels. In the event of a grid outage, the Hub will be energized by the ESS, which will isolate electrically from the main electrical panel. The PV inverter's AC output is connected to the Hub to support solar charging of the battery during a grid outage.

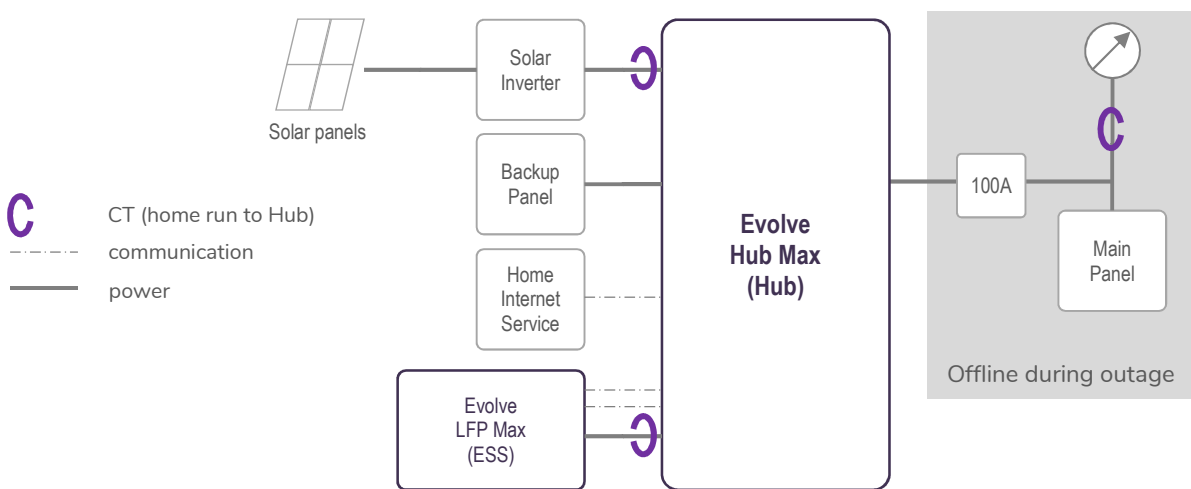

Figure 2: Evolve Hub Max and Evolve LFP Max solar plus storage.

2.5.1 Grid Connected Solar plus Storage

The Hub routes power from the main electrical panel to the backup panel via an internal transfer switch. The EMC inside the Hub commands the battery system to charge or discharge the battery as demanded by the energy management algorithm, using CT measurement of the loads and PV to calculate battery charge/discharge values. In a self-consumption algorithm, for example, the EMC calculates the difference in total load vs. solar PV, and routes the balance of power to/from the battery as needed. When the battery is full, PV power bypasses the battery to grid/loads. When the battery is at minimum reserve, all home loads are supplied entirely by the grid.



Note: The Hub is equipped with an internal automatic bypass switch which provides uninterrupted service to the backup electrical panel when the ESS is either not powered (installed but pending permission to operate) or out of service.

2.5.2 Backup Solar plus Storage

During a grid outage, the Hub islands the battery system and backup electrical panel off the grid. In this mode, the EMC is in a monitoring state, with most control handed over to the ESS. The ESS curtails PV when the battery is either full or exceeds the charge limit of the battery. On low SOC, the battery system goes into a standby state until either the solar resource or the grid returns.



IMPORTANT! Shutting off the ESS circuit breaker at the main electrical panel will place the ESS into backup mode and continue to energize the backup panel.

2.5.3 Backup Solar PV curtailment method: Frequency Shift Power Control (FSPC)

During backup power operation of the ESS, PV curtailment is achieved by shifting the frequency up or down to trip the PV inverter. This curtailment method, defined as frequency shift power control (FSPC), is required to prevent solar from over-charging the battery. By default, the ESS will ramp up frequency to a PV trip range of 62.1 Hz, but this is adjustable depending on the regulatory frequency trip limits within the jurisdiction.

IMPORTANT! PV inverters connected to the backup panel must have frequency trip settings programmed within the following ranges: PV low frequency trip range: 57.0 to 59.3 Hz, PV high frequency trip range: 60.5 to 62.0 Hz.

If the PV inverter cannot be adjusted within the range specified, the PV inverter must not be connected to the backup panel.



Note: The Hub is not suitable for use in applications where the electric utility prohibits PV power export to the grid. For non-export applications, consult your Eguana dealer for alternate Hub solutions.

2.5.4 PV AC input limit

The maximum AC nameplate rating of PV inverters connected to the Evolve Hub Max must not exceed 10 kW.

2.5.5 Over-sized PV systems

For installations with PV systems that are larger than the ESS can accommodate in backup mode, the PV inverters must be split up such that the balance of PV is wired directly to the main electrical panel.

An additional CT must be added to the PV inverter that is connected to the main panel.

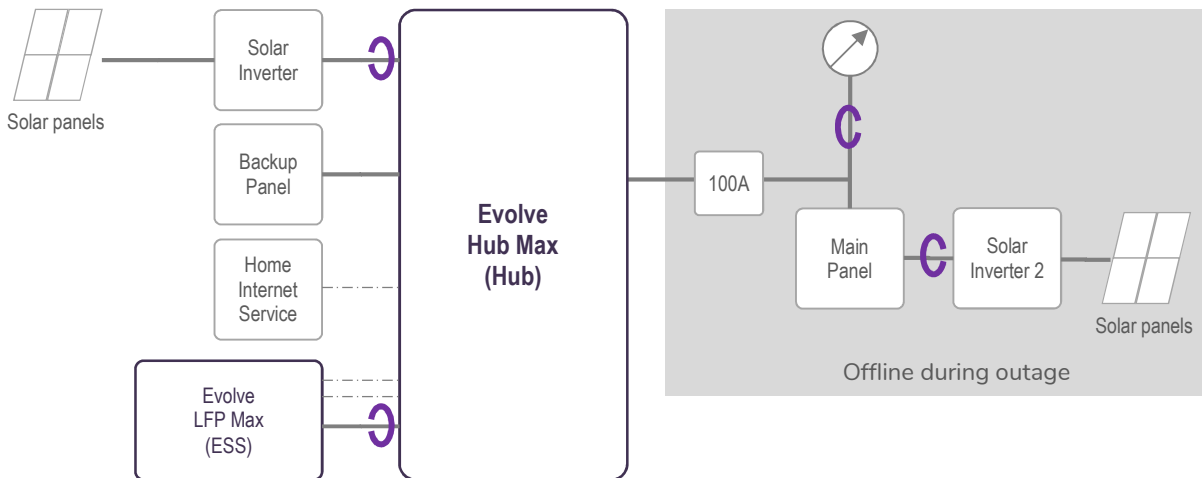

Figure 3: Installing over-sized PV systems.

2.6 Internal Component Overview

The Evolve Hub Max is equipped the following components as identified in the diagram below:

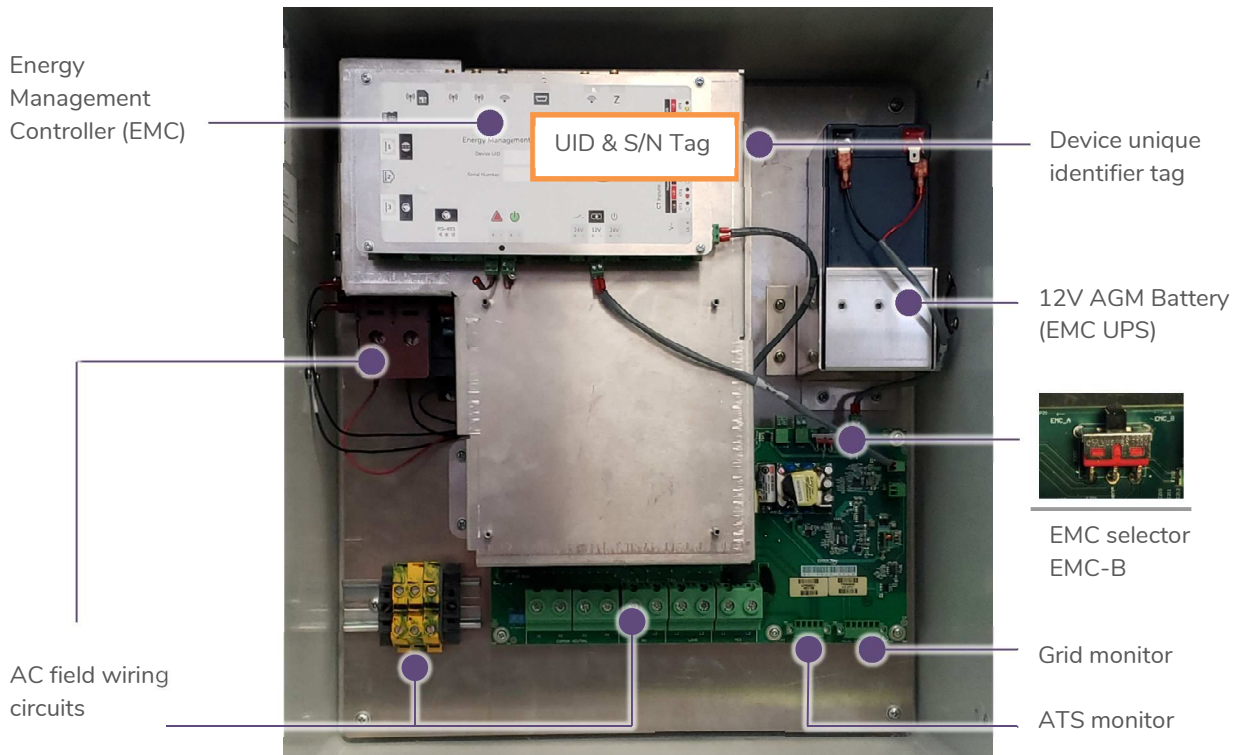

Figure 4: Evolve Hub Max internal component overview.

2.6.1: Energy management controller (EMC)

IMPORTANT! The device unique identifier (UID) & serial number (S/N) tag attached to the front of the EMC is required to register the device to the cloud so that it may be monitored via the Fleet Installer monitoring system. Record this information for online registration.

The EMC performs the following functions:

- Commands the battery system to charge and discharge as defined by the selected control algorithm.
- Monitors the home loads, solar PV, and battery power via on-board 8 channel power meter.
- Provides the Internet gateway to customer supplied internet router via wired Ethernet, wi-fi, or cellular.

A 12V AGM UPS backup battery supplies uninterrupted power to the EMC.

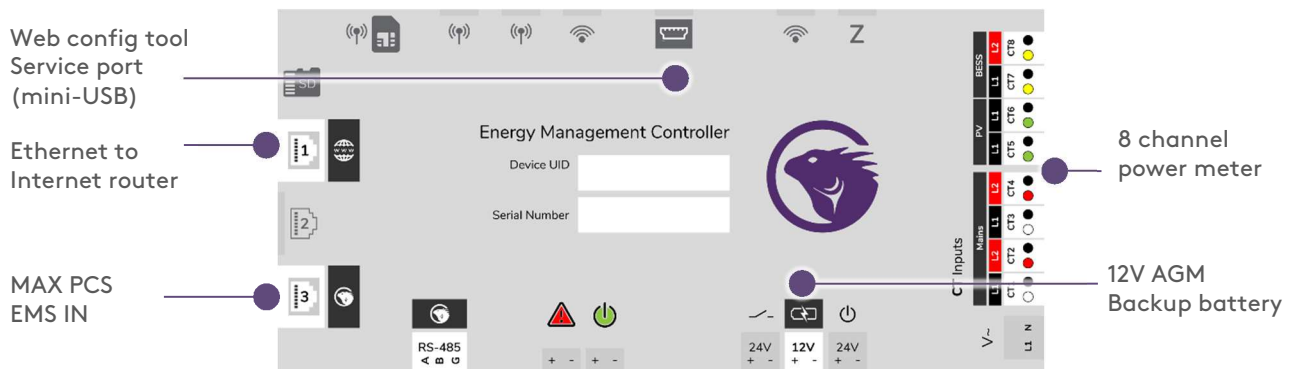

Figure 5: EMC feature overview.

3 Installation Planning

Before installing the Evolve Hub Max, read all instructions and warnings in this manual. The Evolve Hub Max can be installed in an indoor and outdoor non-corrosive environment (not marine environment). Wall mounting hardware is not included.



CAUTION! All electrical installation work should be performed in accordance with local building and electrical codes.



WARNING! Isolate the Evolve Hub Max from all energy sources prior to electrical installation by means of disconnects, breakers or connectors. Failure to properly isolate either AC or DC sources may result in serious injury or death.



NOTE: Communication cables between the Hub and the battery system are limited in length. The Evolve Hub Max should be installed within 2 ft of the battery system.



CAUTION! Do not install in direct sunlight.

3.1 Installation clearances between the Evolve Hub Max and the battery system

The Hub includes communication cables that connect the Hub to the ESS, and are 15 feet in length. As a result, the Hub should not be located more than two feet from the edge of the PCS to ensure the cables can be terminated between devices.

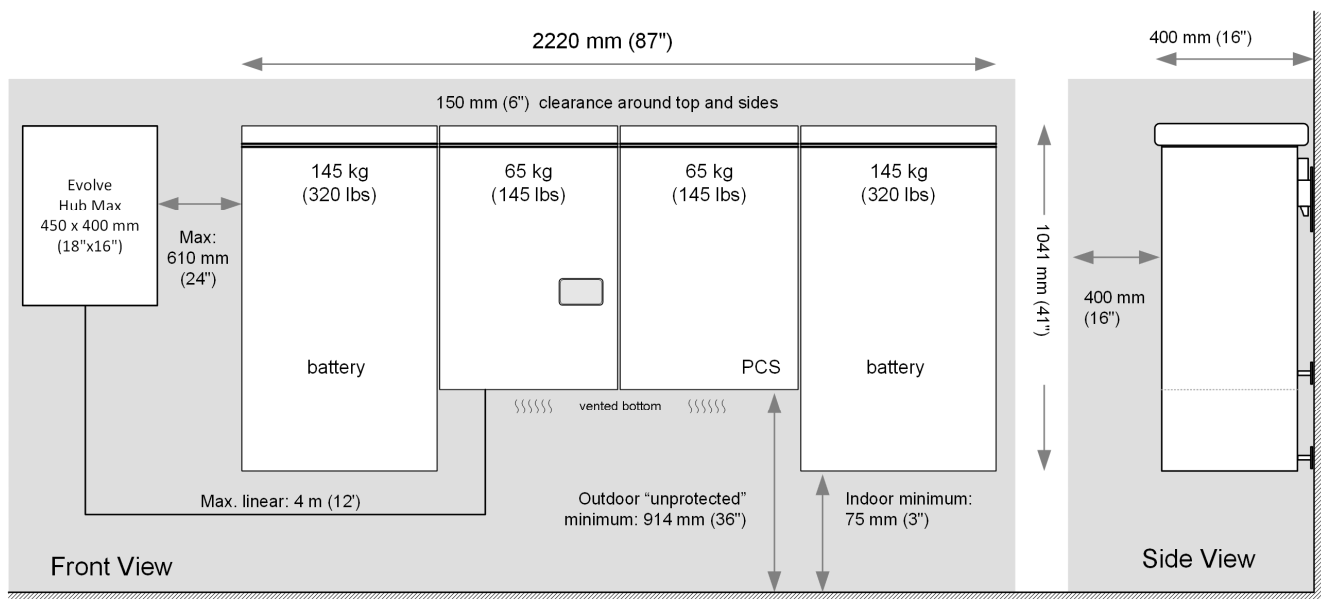

Figure 6: Installation clearances between the Evolve Hub Max and the Evolve LFP Max ESS.

3.2 Installation conduit plan – power and communication circuits

The following example outlines the conduit plan for power and communication circuits for a complete solar plus storage system using the Evolve Hub Max and the ESS. (String PV inverter shown – replace with equivalent AC combined micro-inverter output, where applicable).

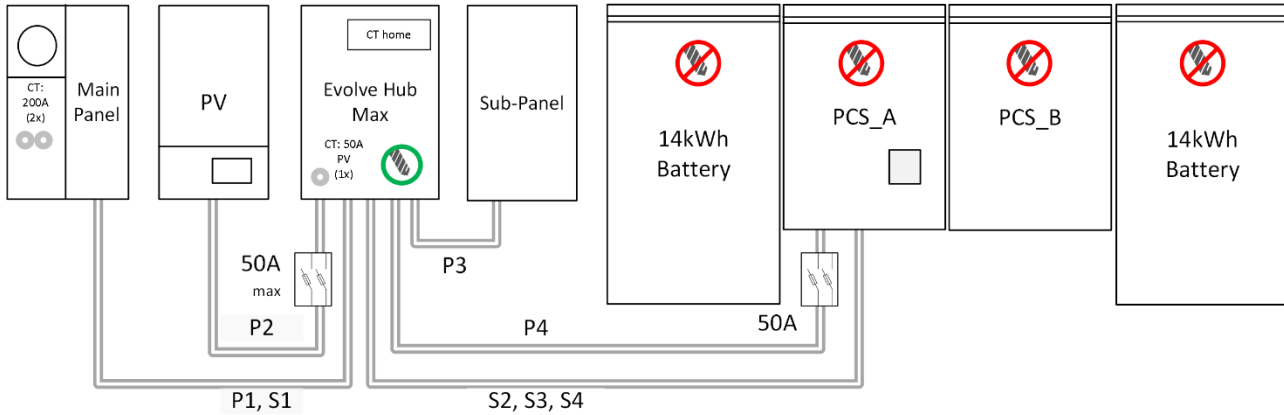

Figure 7: Installation conduit plan for a solar plus storage installation.

Table 1: Circuit summary for a solar plus storage installation.

Conduit Ref	Circuit Definition	Evolve Hub Max	
		Conductor (recommended)	Circuit Protection
P1	Hub grid power	4/3	100 Amp
P2	Solar PV power	-	50 Amp max
P3	Backup panel power	4/3	100 Amp
P4	Evolve LFP Max power	8/3	50 Amp
S1* (x2)	CT, 200 Amp 8ft pigtail	18/2, 300V	-
S2*	Grid monitor	22/6	-
S3*	ATS monitor	18/6	-
S4*	EMC communication	CAT-5	-

*Cables included. CT's are equipped with 8 ft pigtail only. Extensions are customer supplied using 18/2 UTP cable.

Conduit must comply with UL514B.

Disclaimer:

Manufacturer supplied components represented here are limited to the PCS/Battery, Evolve Hub Max, CTs and communication/control cables. All other materials and components represented are customer supplied. CEC/NEC electrical code compliance is the responsibility of the designer and/or electrical permit holder.

3.3 SLD - AC Coupled PV System with Back-up Power Operation

The single line diagram shown below is a representation of a typical installation configured for utility interactive and back-up power operation, including AC coupled PV. This drawing is a guideline only and is not a substitute for a code compliant installation. All components required for a code compliant installation are the responsibility of the licensed installer, including any additional circuit protection requirements not shown here.

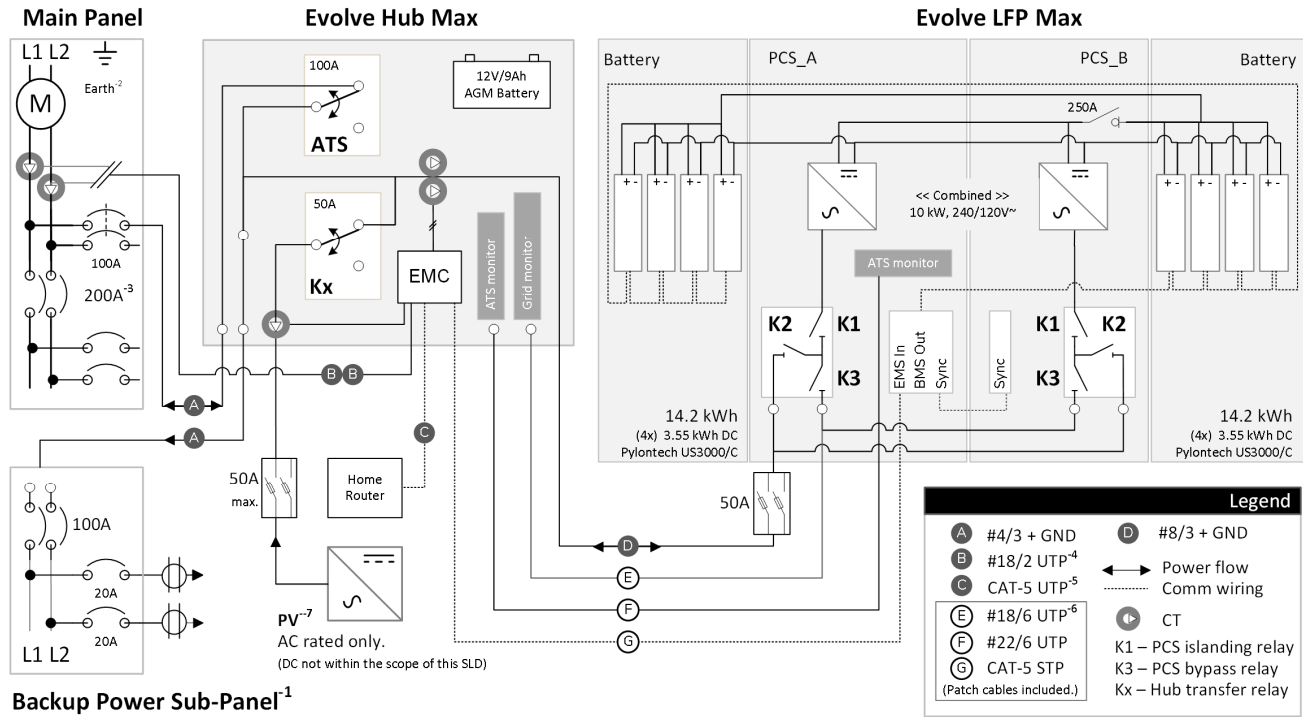

Figure 8: Sample single line diagram of an AC coupled solar plus storage installation.

NOTES

- 1 - The backup power bus must be electrically isolated from the main electrical bus. Do not tap the neutral wires of the main and backup buses. Refer to the installation manual for wiring details. Load circuits are shown for demonstration. Maximum number of circuits determined by sub-panel rating. Loads connected to circuits must not exceed nominal power ratings (continuous/surge) of the inverter.
- 2 - The battery system must be earth bonded to the building ground to meet lightning protection requirements.
- 3 - Line side tapping of the electrical service required for 200 Amp service panels.
- 4 - CTs are equipped with 8 ft pigtails. Twisted pair extensions can be run up to 30 feet. Arrow on CT indicates direction.
- 5 - Ethernet is recommended. EMC can also communicate via Wi-fi.
- 6 - Cable referenced 'E' uses 5 conductors only.
- 7 - Total combined PV output must not exceed 10kW AC during backup operation. PV systems larger than 10kW AC must have a self curtailment mechanism (software or hardware) to ensure limit is within the 10kW AC rating. If curtailment means are not available, balance of PV (if applicable) must be routed directly to the main panel. The fused disconnect shown assumes combined output rating. PV system design is the responsibility of the installer.

Disclaimer:

Manufacturer supplied components represented here are limited to the PCS/Battery, Evolve Hub Max, CTs and communication/control cables. All other materials and components represented are customer supplied. CEC/NEC electrical code compliance is the responsibility of the designer and/or electrical permit holder.

4 Installation Instructions

1. Mount the Evolve Hub Max on the wall using the 4 mounting screw holes on the top and bottom flanges. (Mounting hardware not included).
2. Using the conduit plan in section 2.2, drill the knockout holes required for the conduit runs on the bottom face of the enclosure. Constrain the drill area as shown.
3. Route all conduit as cabling as required. Conduit must comply with UL514B.

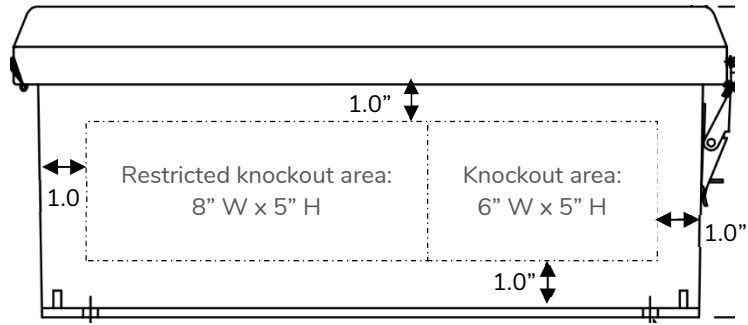

Figure 9: Recommended knock-out area.



CAUTION! All knockout holes must be sealed to maintain the Type 3R environmental rating of the enclosure after the installation is complete.



CAUTION! The restricted knockout area is near the Hub circuitry, so extra care must be taken to avoid internal components when the knockout holes are being drilled.



CAUTION! Ensure that the enclosure door is properly seated such that the gasket becomes compressed when the door is securely closed.

5 Electrical Wiring Instructions



IMPORTANT! Wiring methods must be in accordance with local electrical codes. The installer is responsible for ensuring that over-current protection is installed and sized appropriately for the AC circuits, in accordance with the National Electrical Code, ANSI/NFPA 70, Canadian Electrical Code and local codes

The patch cables provided in section 4.1 and 4.2 below have pre-assembled connectors at both ends. It is strongly recommended that these cables are pulled in conduit prior to the power cables.



CAUTION! Do not install cables if any wires appear damaged or are not terminated improperly. Contact your Eguana distributor for support.

5.1 EMC to PCS cable

1. Terminate the EMC CAT 5 patch cable from the EMS IN port of the PCS to **ethernet port 3** of the EMC.



Note: If a longer extension is required, shielded CAT 5/6 cable must be used.

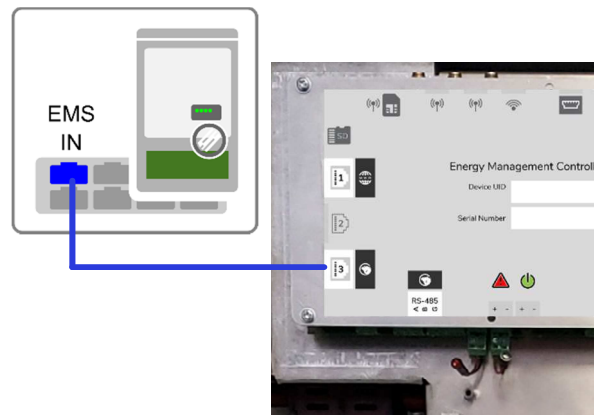

Figure 10: EMC cable connection to RJ-45 port.

5.2 Grid & ATS monitoring cables

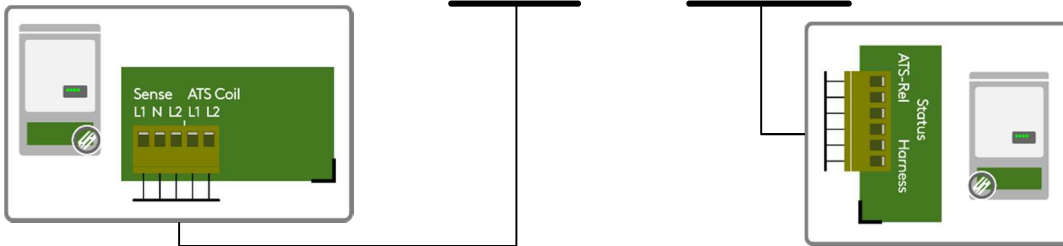
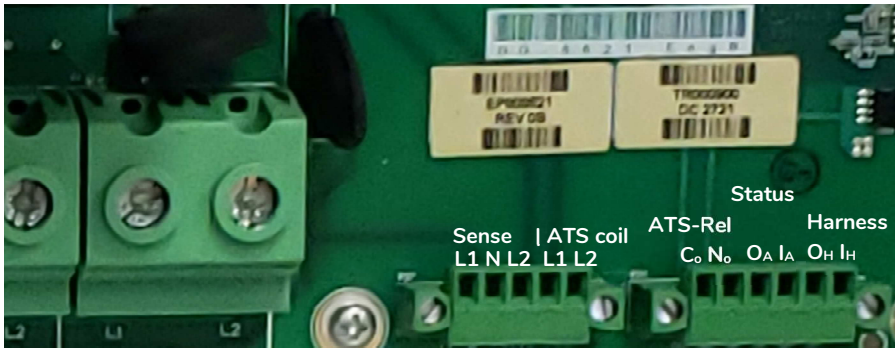

Figure 11: Grid and ATS monitoring cable

5.3 AC power wiring



IMPORTANT! Do not terminate fine stranded cable in the connectors without the use of ferrules.



CAUTION! To reduce the risk of fire, connect only to a dedicated circuit provided with appropriate branch circuit over-current protection in accordance with local electrical codes.



WARNING! Improper connection of the wiring panel may result in equipment damage and cause personal injury. Disconnect all AC and DC Sources prior to installation.



CAUTION! The AC load feeds a dedicated backup sub-panel, the source of which is controlled internally by an automatic bypass and transfer switch. Do not tap line or neutral wires directly from the main electrical panel to the backup panel. The neutrals of both panels must be electrically isolated for safe operation.

5.3.1 Phase orientation in split phase 120/240 systems

The EMC derives power measurement at the main service, the solar PV inverter AC output, and the ESS. Consistent phase voltage orientation through the entire installation is critical to proper control of the system. The initial selection of the phase voltage defined as L1 is established by the placement of the CT referenced as CT1 on the main feeder to the panel. To ensure the phase wiring to the Evolve Hub maintains consistent polarity, measure the AC voltage between L1 of the main feeder and the Grid terminals of the Evolve Hub. The pole that measures 0.0 VAC is defined herein as L1 for the AC wiring instructions that follow.

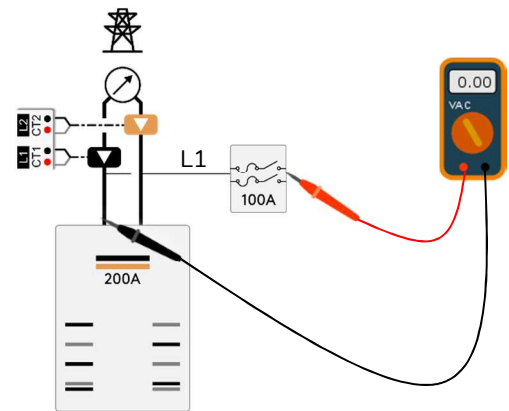

Figure 12: Defining L1 with CT1 in the main panel.

5.3.2 Main electrical panel

Route “AC Grid” L1, L2, Neutral, and Ground to a dedicated 2-pole 100 backfeed rated disconnect that is line-tapped to the main electrical panel.

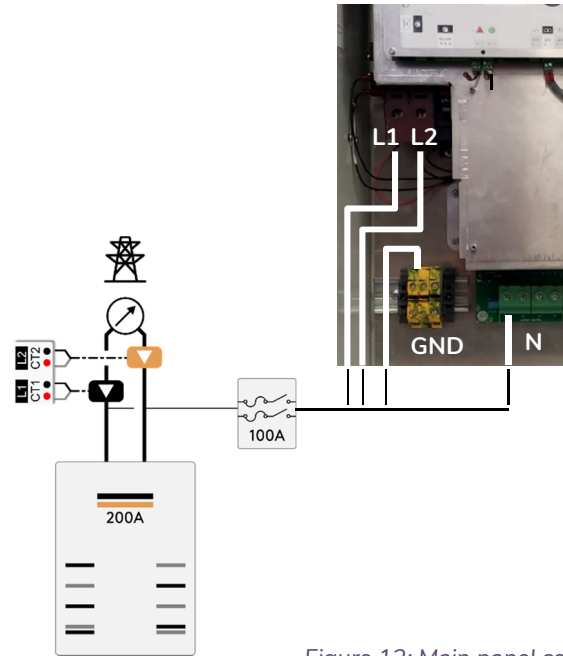

Figure 12: Main panel connection.

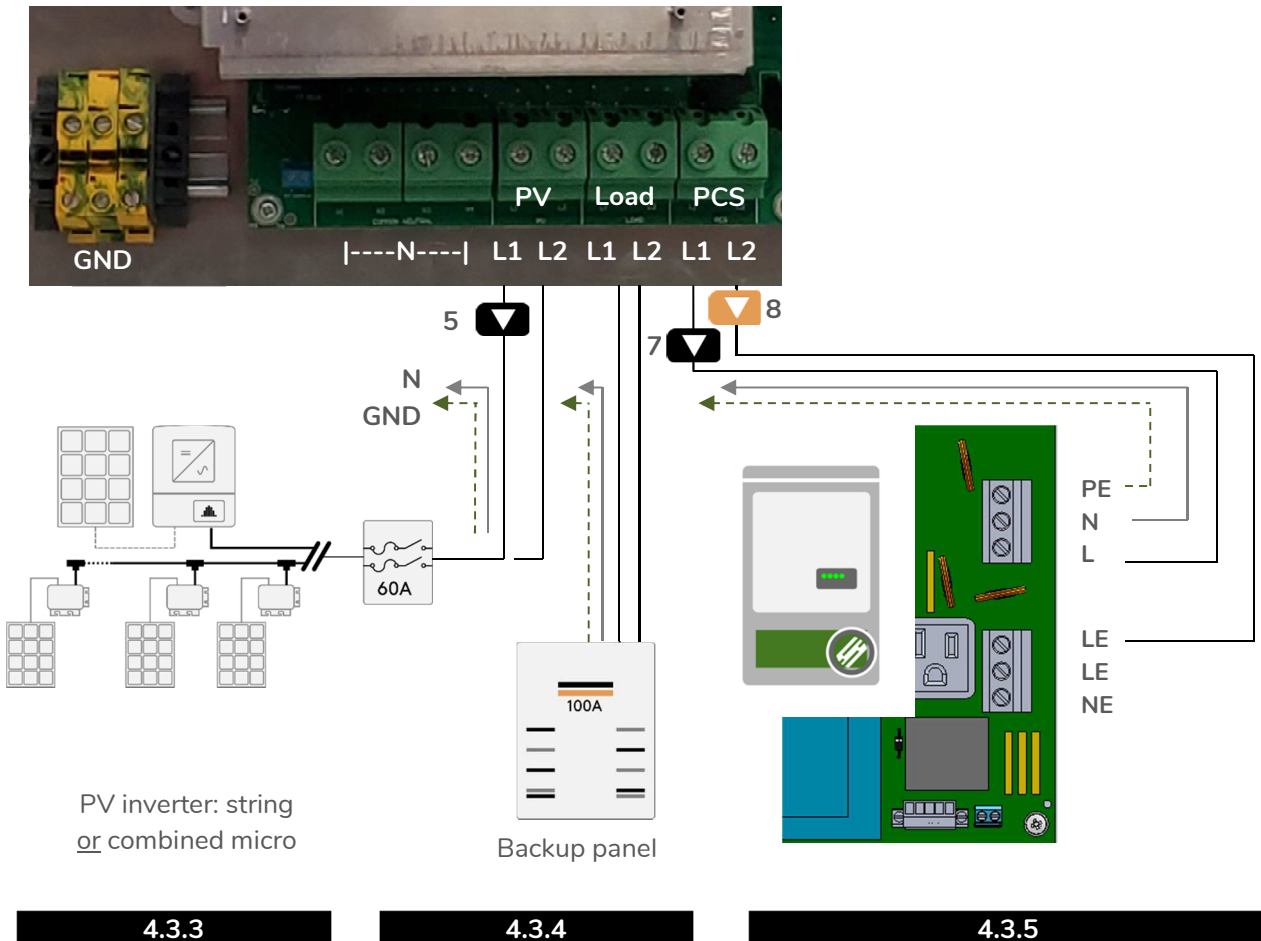

Figure 13: Max Hub AC port connections.

Refer to the above diagram for the wiring connections in the following sections. Neutral and ground connections for the sections below are terminated at the common neutral and ground bus respectively.

5.3.3 PV

Terminate L1, L2, Neutral, and Ground at the Hub's load port from the AC output of the PV inverter (either string or combined micro inverter output).

5.3.4 Load (Backup panel)

Terminate L1, L2, Neutral, and Ground at the Hub's load port from the 100 Amp backup panel.

5.3.5 LFP Max PCS

Terminate L1, L2, Neutral, and Ground at the Hub's PCS port from the Evolve LFP Max PCS grid/extension ports.

5.4 CT connections

IMPORTANT! The energy management system relies on the correct CT orientation for each of the measured loads, PV, and ESS. Follow these instructions with care.



Note: the positive signal wire is white and negative signal wire is black for all CT models.

5.4.1 Main electrical panel CTs

CT direction faces into the home loads (away from utility meter). Current measurement is positive when load exceeds generation.

1. CT1 - line side of the L1 feeder tap in the electrical panel.
2. CT2 - line side of the L2 feeder tap in the electrical panel.

5.4.2 Solar PV CT

CT direction faces into the solar PV inverter. Current measurement is negative when PV is generating.

1. CT5 - L1 input of the solar circuit within the Hub.

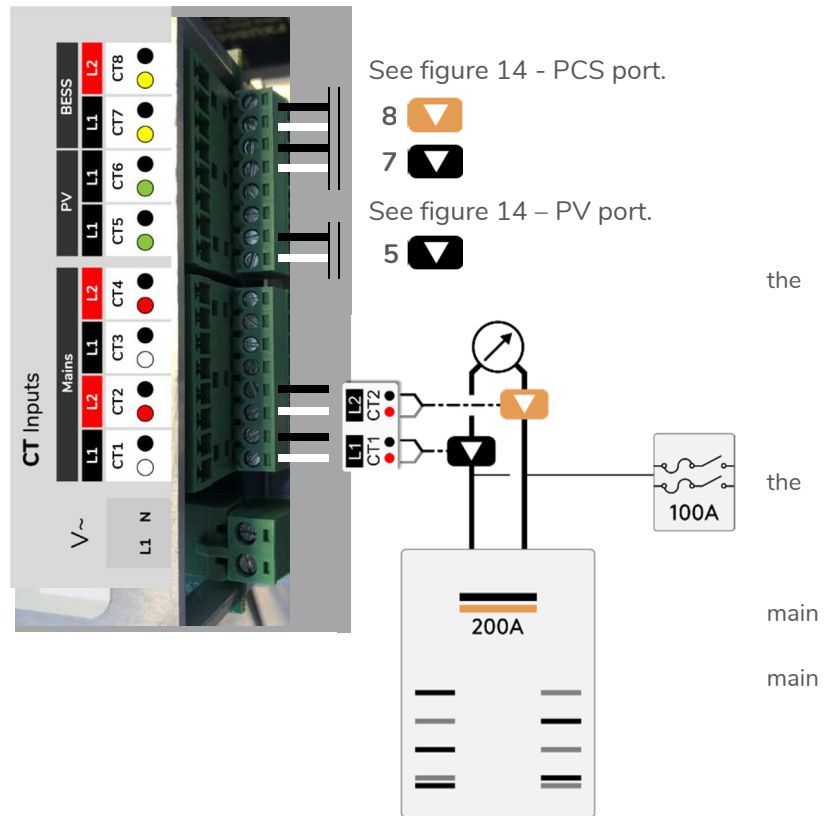

Figure 14: Main panel CT connections: Channels 1 & 2.

5.4.3 PCS CTs

CT direction faces into the Evolve ESS / LFP
 Current measurement is positive when battery is charging
 and negative when discharging.

1. CT7 – L1 input of the PCS port within the Hub.
2. CT8 – L2 input of the PCS port within the Hub.

5.5 12V backup battery



IMPORTANT! Do not complete this connection until the customer receives permission to operate the system, and the main panel Evolve Hub breaker is ON. The EMC will be powered when the 12V battery is connected. Failure to comply with this instruction may cause irreversible damage to the battery due to battery drainage without a charge source.

1. Terminate the positive wire on the AGM battery.



Figure 15: Connecting the AGM battery after permission to operate.

6 Operation



The EMC inside the Hub is commissioned using a web browser. Refer to the Fleet Installer Administration Guide and the Quick Commissioning Guide for complete instructions on setup for the Evolve battery system.

6.1 EMC selector switch: EMC_B

Ensure that the EMC selector switch is in position EMC_B.

6.2 Pre-startup checklist

The following is a recommended quality inspection checklist prior to power up of the system.

Status	Inspection	Reference
(√)	EMC selector switch set to position B.	Figure 23
	Ground continuity test – inspect and test ground continuity between the Evolve Hub and Evolve ESS / LFP.	

6.3 Startup



IMPORTANT! The Evolve Hub Max must be commissioned as part of the Evolve LFP Max. The startup procedure provided below presumes that the PCS contained within the Evolve LFP Max is powered from the battery (DC source), and that the PCS is currently displaying a valid SOC range and is operating in sleep/standby mode. Refer to the startup sequence of the Evolve LFP Max Installation and Startup Guide to power up the ESS. If an AC has been installed between the Hub port and the battery system, leave it in the OFF position until the power up of the Hub has been completed.

1. Turn ON the Evolve Hub Max AC source circuit.

Powering up the Hub will supply power to the on-board EMC. The red and green lights on the bottom of the EMC will flash for approximately 30 seconds, indicating its initialization sequence. Following initialization, the lights will remain solid.

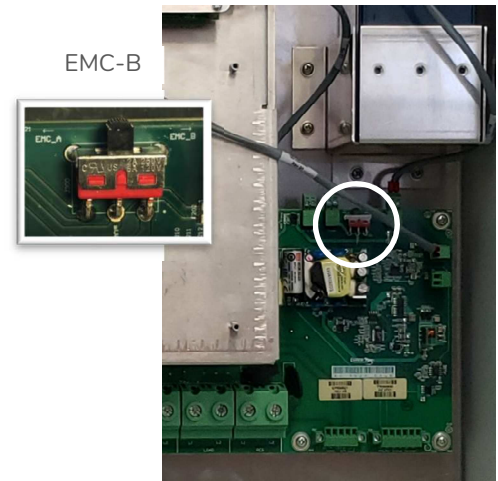

Figure 16: EMC selector switch in position EMC-B.



CAUTION! Following initial power up of the Evolve LFP Max, shutting OFF the Hub breaker at the main electrical panel will automatically engage the ESS backup power source. **The Hub will remain energized at the PCS, Load, and PV ports while the ESS is in backup mode.**

6.4 Post-startup checklist

The following is a recommended quality inspection checklist following power up of the system.

Status (✓)	Inspection	Reference
	EMC power up status: Green/Red LEDs flashing up to 30 seconds, then solid Green and Red.	Figure 16
	Measure AC voltage at the AC_Grid port (ATS Input terminals. (L1-N, L2-N)	Figure 13
	Measure AC voltage at the load (backup panel connection) port. (L1-N, L2-N)	Figure 14

7 Maintenance

The Evolve Hub Max is a maintenance free product. Annual inspection is recommended to ensure the enclosure maintains mechanical integrity (mounting and environmental protection) and the ventilators are free from obstruction. For heavy soiling use a soft, dry brush to clean. Do not use any solvents, scouring, or corrosive materials to clean the unit. Never remove or unplug connections or plugs during cleaning.

8 Troubleshooting

The following is a troubleshooting guide for the Evolve Hub. Refer to the Evolve ESS / LFP Installation and Startup manual for troubleshooting the battery system.

Mode	Condition	Check
Grid connected	No power to Evolve Hub and backup panel.	Check Evolve Hub breaker circuit at the main panel.
Grid connected	No PV power output	Check PV breaker in the backup panel.
Commissioning / Grid connected	Battery does not charge when PV is operating	<ol style="list-style-type: none"> 1. Check CT configuration. PV measurement is negative when operating. 2. Check battery SOC (battery does not charge when full). 3. EMS operating in solar self-consumption mode, and home loads are greater than PV.
Grid connected & Backup	Monitoring system not displaying information in web portal.	Check internet connection. Check power (Green LED) on the EMC panel.
Backup (grid outage)	No power to backup loads	Check status of the Evolve LFP Max on the front of the PCS panel. Refer to the Evolve LFP Max Installation & Startup Guide for more details.

9 Technical Data

9.1 Electrical specifications



Note: About these ratings - The Evolve Hub is a peripheral component of the Evolve ESS / LFP. It is a power distribution center with an on-board energy management system. As such, this product is defined under the category of Interconnection System Equipment (ISE) for use in utility interactive and/or stand-alone power systems under the scope of the UL1741 Standard, and is intended to be operated in parallel with an electric power system (EPS) to supply power to common loads. The Evolve Hub as a standalone device does not provide grid-interactive functionality. Where necessary, the ratings included below are listed both as a standalone product, as well as in conjunction with the Standard for Interconnecting Distributed Resources With Electric Power Systems, IEEE 1547, and the Standard for Conformance Test Procedures for Equipment Interconnecting Distributed Resources with Electric Power Systems, IEEE 1547.1.

AC ratings – Power distribution circuits	
Nominal Grid voltage	240V/120V split phase
Nominal Grid frequency	60 Hz
Maximum AC fault current and duration (short circuit)	14.0 Apk, 2.5 Arms (duration 63.5 ms)
AC voltage operating range	Max: 100 to 264 Vac. Note: UL 1741SA compliant operating limits are determined by the Evolve ACB05U-PP configuration settings
AC frequency operating range	Max: 47 to 63 Hz. Note: UL1741SA compliant operating limits are determined by the ACB05U-LP configuration settings
AC connections, number - type	4 – Grid, Load, PCS, PV
Grid Port (ATS Input) and Load Port: Maximum continuous operating current (or Rated current)	100.0 Amps
Maximum continuous operating power (or Rated power), VA	9600 VA
PCS Port and PV Port: Maximum continuous operating current (or Rated current)	50.0 Amps
Protective Class (I, II, or III)	Class I
Over-Voltage Category (OVC I, II, III, or IV)	OVC III
Pollution Degree	3
Lightning protection	IEEE 62.41.2, location category B, low exposure
Short circuit current rating	22 kA
General data	
Width x height x depth	19.5" x 17.5" x 9" (495 x 445 x 229 mm)
Weight	35 lbs (15.9 kg)
Protection type	Type 3R
Ambient temperature, relative humidity, altitude	-20 °C to +50 °C, 95%, 2000 m
Installation type	Wall-mount (upright)
Enclosure material	Halogen free, self extinguishing fiberglass reinforced polyester
For use only with the Eguana LFP Max energy storage system.	

9.2 Wire and torque ratings

Use copper only, 90 °C or higher rating (do not use fine strand)

PCS (AC)	# conductors	AWG (min to max)	Torque
AC grid (ATS input)	3 conductor + PE	4 AWG to 2/0 AWG	45 in-lbs (4 AWG)
			50 in-lbs (2 AWG to 2/0 AWG)
AC load, PV, PCS	3 conductor + PE	8 AWG to 2 AWG	25 in-lbs (8 AWG)
			35 in-lbs (6 to 3 AWG)
			40 in-lbs (2 AWG)
Ground Lug	1 conductor	8 AWG to 6 AWG	25 in-lbs (8 AWG)
			35 in-lbs (6 AWG)

